



M
M A R L • W

**HARDWARE
CATALOG**



PUCKS & CAPS

4-6



SPACERS & STANDOFFS

7-13



MISC

14



GENERAL HARDWARE

15



MADE TO ORDER

16

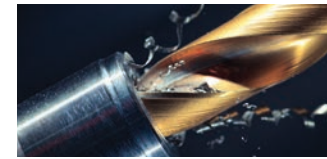

CUSTOM MACHINING

17



DIAGRAMS

18-21



ABOUT US

22



TERMS AND CONDITIONS

23

PUCKS & CAPS

Our assortment of caps and pucks (adding a threaded stud) available in a wide variety of sizes, materials and finishes.



Standard Puck/Cap

Caps are the face of the puck and standoff system. Our caps can be turned into a versatile fastener compatible with our spacers, standoffs or any other threaded application by bonding a zinc-plated stud to it. We manufacture our pucks and caps to fit your needs. If you are unsure of the length of thread needed, let one of our trained professionals help you get the perfect puck for your situation.

Part Number	Diameter	Thread Size	With Stud	Cap Only	Finish
C-038-10-AL	3/8"	10 - 24	\$2.71	\$2.06	Anodized Aluminum
C-050-14-AL	1/2"	1/4 - 20	\$2.78	\$2.12	Anodized Aluminum
C-050-10-AL	1/2"	10 - 24	\$2.78	\$2.12	Anodized Aluminum
C-062-14-AL	5/8"	1/4 - 20	\$2.83	\$2.17	Anodized Aluminum
C-075-14-AL	3/4"	1/4 - 20	\$2.89	\$2.23	Anodized Aluminum
C-100-14-AL	1"	1/4 - 20	\$3.03	\$2.37	Anodized Aluminum
C-100-516-AL	1"	5/16 - 18	\$3.03	\$2.37	Anodized Aluminum
C-125-14-AL	1 1/4"	1/4 - 20	\$3.44	\$2.78	Anodized Aluminum
C-125-516-AL	1 1/4"	5/16 - 18	\$3.44	\$2.78	Anodized Aluminum
C-150-516-AL	1 1/2"	5/16 - 18	\$4.18	\$3.52	Anodized Aluminum

When ordering pucks, please specify needed stud length.

Contact us for additional sizes, finishes or quantities over 100 pieces.
Orders under \$100 with be assessed a \$17.50 shipping & handling fee.

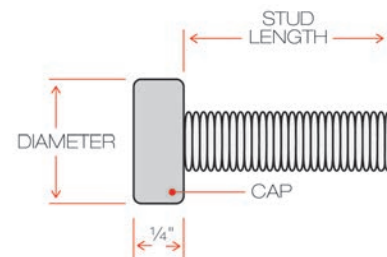

Standard Puck/Cap (Continued)

Part Number	Diameter	Thread Size	With Stud	Cap Only	Finish
C-050-14-SB	1/2"	1/4 - 20	\$3.01	\$2.35	Stainless Steel Brushed
C-075-14-SB	3/4"	1/4 - 20	\$3.39	\$2.73	Stainless Steel Brushed
C-100-14-SB	1"	1/4 - 20	\$3.85	\$3.19	Stainless Steel Brushed
C-100-516-SB	1"	5/16 - 18	\$3.85	\$3.19	Stainless Steel Brushed
C-125-14-SB	1 1/4"	1/4 - 20	\$4.57	\$3.91	Stainless Steel Brushed

When ordering pucks, please specify needed stud length.



Low Profile Puck/Cap

This cap has the same function and finish of our standard cap but in a short low profile look. This hardware will add style to your sign or display without standing out. This cap is also available as a puck with a threaded stud.

Part Number	Diameter	Thread Size	Shoulder Diameter	With Stud	Cap Only	Finish
LC-075-14-AL	3/4"	1/4 - 20	-	\$3.78	\$3.12	Anodized Aluminum
LC-100-14-AL	1"	1/4 - 20	-	\$3.98	\$3.32	Anodized Aluminum
LC-100-516-AL	1"	5/16 - 18	-	\$3.98	\$3.32	Anodized Aluminum
LC-125-14-AL	1 1/4"	1/4 - 20	3/8"	\$5.47	\$4.81	Anodized Aluminum
LC-125-516-AL	1 1/4"	5/16 - 18	7/16"	\$5.47	\$4.81	Anodized Aluminum
LC-150-516-AL	1 1/2"	5/16 - 18	3/8"	\$6.21	\$5.55	Anodized Aluminum

When ordering pucks, please specify needed stud length.

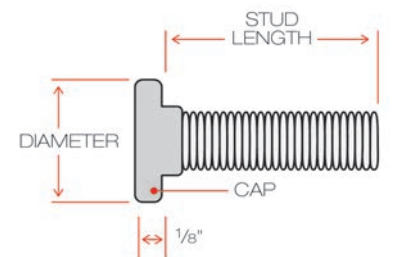

Contact us for additional sizes, finishes or quantities over 100 pieces.
Orders under \$100 with be assessed a \$17.50 shipping & handling fee.

Quick-Puck

This cap is not threaded but it allows the use of any type of fastener including anti-theft hardware, to tighten your cap down. With the head of the fastener countersunk into the cap but still exposed, it makes it easy to be able to take down and put back up at any time.

Part Number	Diameter	Thread Size	0-100 Pcs.	Finish
QP-050-AL	1/2"	Used with any #10 fastener	\$2.55	Anodized Aluminum
QP-075-AL	3/4"	Used with any 1/4 fastener	\$2.67	Anodized Aluminum
QP-100-AL	1"	Used with any 1/4 fastener	\$2.81	Anodized Aluminum
QP-125-AL	1 1/4"	Used with any 5/16" fastener	\$3.22	Anodized Aluminum

Hardware not included

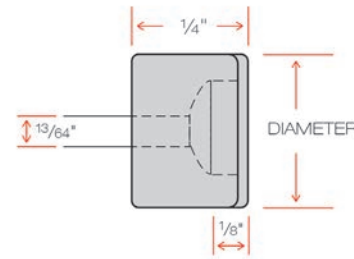
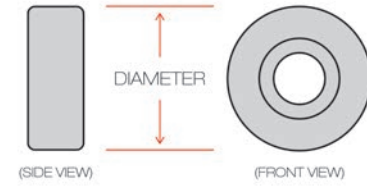

Security Cap

Cap utilizes a cup point set screw in the side of the cap that tightens down on a stud or fastener, preventing the cap from being removed without tools. Can be paired with any of the "original" puck, cap, spacer and standoff hardware.

Part Number	Diameter	Thread Size	With Stud	Cap Only	Finish
SC-075-14-AL	3/4"	1/4 - 20	\$6.27	\$5.67	Anodized Aluminum
SC-100-14-AL	1"	1/4 - 20	\$6.40	\$5.80	Anodized Aluminum
SC-100-516-AL	1"	5/16 - 18	\$6.40	\$5.80	Anodized Aluminum
SC-125-14-AL	1 1/4"	1/4 - 20	\$6.82	\$6.22	Anodized Aluminum
SC-125-516-AL	1 1/4"	5/16 - 18	\$6.82	\$6.22	Anodized Aluminum
SC-150-516-AL	1 1/2"	5/16 - 18	\$7.55	\$6.95	Anodized Aluminum

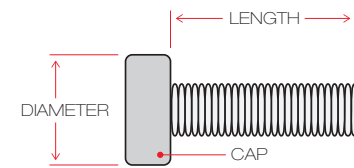

SPACERS & STANDOFFS

Our threaded standoffs are designed to work with any of our pucks and caps. Our spacers have a clearance hole (no threads) to fit whatever size thread is needed.



Standard Spacer

These spacers have a clearance hole passing through its entire length with no threads. Spacers are most commonly used when you want the same fastener to pass through the entire barrel and through the panel being mounted, and have a cap screw it all together.

Part Number	Diameter	Length	Hole Size	Compatible Thread Size	0-100 Pcs.	Finish
S-038-025-10-AL	3/8"	1/4"	7/32"	10-24	\$2.24	Anodized Aluminum
S-038-050-10-AL	3/8"	1/2"	7/32"	10-24	\$2.32	Anodized Aluminum
S-038-075-10-AL	3/8"	3/4"	7/32"	10-24	\$2.40	Anodized Aluminum
S-038-100-10-AL	3/8"	1"	7/32"	10-24	\$2.48	Anodized Aluminum
S-050-050-10-AL	1/2"	1/2"	7/32"	10-24	\$2.39	Anodized Aluminum
S-050-050-14-AL	1/2"	1/2"	9/32"	1/4 - 20	\$2.39	Anodized Aluminum
S-050-075-10-AL	1/2"	3/4"	7/32"	10-24	\$2.46	Anodized Aluminum
S-050-075-14-AL	1/2"	3/4"	9/32"	1/4 - 20	\$2.46	Anodized Aluminum
S-050-100-10-AL	1/2"	1"	7/32"	10-24	\$2.53	Anodized Aluminum
S-050-100-14-AL	1/2"	1"	9/32"	1/4 - 20	\$2.53	Anodized Aluminum
S-075-050-14-AL	3/4"	1/2"	9/32"	1/4 - 20	\$2.40	Anodized Aluminum
S-075-075-14-AL	3/4"	3/4"	9/32"	1/4 - 20	\$2.29	Anodized Aluminum

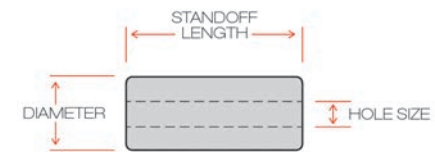
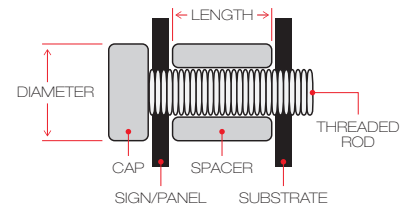

Contact us for additional sizes, finishes or quantities over 100 pieces.
Orders under \$100 will be assessed a \$17.50 shipping & handling fee.

Contact us for additional sizes, finishes or quantities over 100 pieces.
Orders under \$100 will be assessed a \$17.50 shipping & handling fee.

Standard Spacer (Continued)

Part Number	Diameter	Length	Hole Size	Compatible Thread Size	0-100 Pcs.	Finish
S-075-100-14-AL	3/4"	1"	9/32"	1/4-20	\$2.51	Anodized Aluminum
S-075-150-14-AL	3/4"	1 1/2"	9/32"	1/4-20	\$2.82	Anodized Aluminum
S-100-050-14-AL	1"	1/2"	9/32"	1/4-20	\$2.50	Anodized Aluminum
S-100-050-516-AL	1"	1/2"	11/32"	5/16-18	\$2.50	Anodized Aluminum
S-100-075-14-AL	1"	3/4"	9/32"	1/4-20	\$2.60	Anodized Aluminum
S-100-075-516-AL	1"	3/4"	11/32"	5/16-18	\$2.60	Anodized Aluminum
S-100-100-14-AL	1"	1"	9/32"	1/4-20	\$2.70	Anodized Aluminum
S-100-100-516-AL	1"	1"	11/32"	5/16-18	\$2.70	Anodized Aluminum
S-100-150-14-AL	1"	1 1/2"	9/32"	1/4-20	\$2.86	Anodized Aluminum
S-100-150-516-AL	1"	1 1/2"	11/32"	5/16-18	\$2.86	Anodized Aluminum

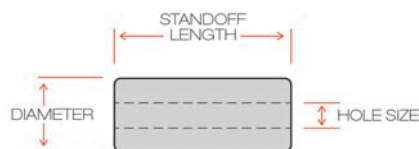
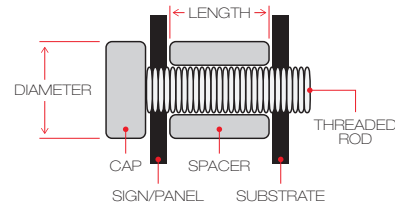

Threaded Standoff (Continued)

Part Number	Diameter	Length	Thread Depth	Thread Size	0-100 Pcs.	Finish
ST-050-050-10-AL	1/2"	1/2"	Thru.	10-24	\$2.74	Anodized Aluminum
ST-050-050-14-AL	1/2"	1/2"	Thru.	1/4-20	\$2.74	Anodized Aluminum
ST-050-075-10-AL	1/2"	3/4"	Thru.	10-24	\$3.10	Anodized Aluminum
ST-050-075-14-AL	1/2"	3/4"	Thru.	1/4-20	\$3.10	Anodized Aluminum
ST-050-100-10-AL	1/2"	1"	1/2"	10-24	\$3.47	Anodized Aluminum
ST-050-100-14-AL	1/2"	1"	Thru.	1/4-20	\$3.47	Anodized Aluminum
ST-050-150-10-AL	1/2"	1 1/2"	5/8"	10-24	\$3.56	Anodized Aluminum
ST-050-150-14-AL	1/2"	1 1/2"	3/4"	1/4-20	\$3.56	Anodized Aluminum
ST-050-200-10-AL	1/2"	2"	5/8"	10-24	\$3.66	Anodized Aluminum
ST-050-200-14-AL	1/2"	2"	3/4"	1/4-20	\$3.66	Anodized Aluminum
ST-075-050-14-AL	3/4"	3/4"	Thru.	1/4-20	\$2.90	Anodized Aluminum
ST-075-075-14-AL	3/4"	3/4"	Thru.	1/4-20	\$3.19	Anodized Aluminum
ST-075-100-14-AL	3/4"	1"	Thru.	1/4-20	\$3.74	Anodized Aluminum
ST-075-150-14-AL	3/4"	1 1/2"	3/4"	1/4-20	\$4.07	Anodized Aluminum
ST-075-200-14-AL	3/4"	2"	3/4"	1/4-20	\$4.42	Anodized Aluminum
ST-100-050-14-AL	1"	1/2"	Thru.	1/4-20	\$3.43	Anodized Aluminum
ST-100-050-516-AL	1"	1/2"	Thru.	5/16-18	\$3.43	Anodized Aluminum
ST-100-075-14-AL	1"	3/4"	Thru.	1/4-20	\$3.85	Anodized Aluminum
ST-100-075-516-AL	1"	3/4"	Thru.	5/16-18	\$3.85	Anodized Aluminum

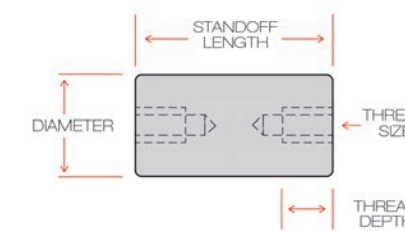
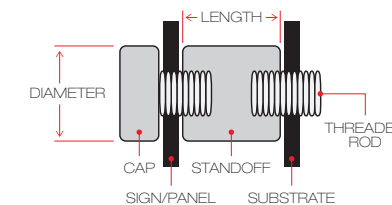

Threaded Standoff

Standoffs are a barrel that has internal threads. They can either be threaded the entire length or from each end depending on the part's overall length. This allows you to use a fastener to mount the standoff on one end and a puck to mount your panel on the other end. You can then hang or change panels without having to take the whole assembly down.

Part Number	Diameter	Length	Thread Depth	Thread Size	0-100 Pcs.	Finish
ST-038-025-10-AL	3/8"	1/4"	Thru.	10-24	\$2.31	Anodized Aluminum
ST-038-050-10-AL	3/8"	1/2"	Thru.	10-24	\$2.67	Anodized Aluminum
ST-038-075-10-AL	3/8"	3/4"	Thru.	10-24	\$3.04	Anodized Aluminum
ST-038-100-10-AL	3/8"	1"	1/2"	10-24	\$3.40	Anodized Aluminum



Contact us for additional sizes, finishes or quantities over 100 pieces.
Orders under \$100 will be assessed a \$17.50 shipping & handling fee.

Contact us for additional sizes, finishes or quantities over 100 pieces.
Orders under \$100 will be assessed a \$17.50 shipping & handling fee.

Threaded Standoff (Continued)

Part Number	Diameter	Length	Thread Depth	Thread Size	0-100 Pcs.	Finish
ST-100-100-14-AL	1"	1"	Thru.	1/4 - 20	\$4.27	Anodized Aluminum
ST-100-100-516-AL	1"	1"	Thru.	5/16 - 18	\$4.27	Anodized Aluminum
ST-100-150-14-AL	1"	1 1/2"	3/4"	1/4 - 20	\$4.81	Anodized Aluminum
ST-100-150-516-AL	1"	1 1/2"	3/4"	5/16 - 18	\$4.81	Anodized Aluminum
ST-100-200-14-AL	1"	2"	3/4"	1/4 - 20	\$5.37	Anodized Aluminum
ST-100-200-516-AL	1"	2"	3/4"	5/16 - 18	\$5.37	Anodized Aluminum
ST-100-300-14-AL	1"	3"	3/4"	1/4 - 20	\$6.06	Anodized Aluminum
ST-100-300-516-AL	1"	3"	3/4"	5/16 - 18	\$6.06	Anodized Aluminum
ST-125-050-516-AL	1 1/4"	1/2"	Thru.	5/16 - 18	\$4.22	Anodized Aluminum
ST-125-100-516-AL	1 1/4"	1"	1/2"	5/16 - 18	\$4.95	Anodized Aluminum
ST-125-200-516-AL	1 1/4"	2"	3/4"	5/16 - 18	\$5.64	Anodized Aluminum
ST-125-300-516-AL	1 1/4"	3"	3/4"	5/16 - 18	\$6.53	Anodized Aluminum
ST-125-400-516-AL	1 1/4"	4"	3/4"	5/16 - 18	\$7.42	Anodized Aluminum
ST-150-050-516-AL	1 1/2"	1/2"	Thru.	5/16 - 18	\$4.81	Anodized Aluminum
ST-150-100-516-AL	1 1/2"	1"	Thru.	5/16 - 18	\$5.60	Anodized Aluminum
ST-150-200-516-AL	1 1/2"	2"	1"	5/16 - 18	\$7.81	Anodized Aluminum
ST-150-300-516-AL	1 1/2"	3"	1"	5/16 - 18	\$9.91	Anodized Aluminum
ST-150-400-516-AL	1 1/2"	4"	1"	5/16 - 18	\$12.07	Anodized Aluminum



Threaded Standoff (Continued)

Part Number	Diameter	Length	Thread Depth	Thread Size	0-100 Pcs.	Finish
ST-050-050-10-SB	1/2"	1/2"	Thru.	10-24	\$3.01	Stainless Steel Brushed
ST-050-075-10-SB	1/2"	3/4"	Thru.	10-24	\$3.41	Stainless Steel Brushed
ST-050-100-10-SB	1/2"	1"	1/2"	10-24	\$3.81	Stainless Steel Brushed
ST-050-150-10-SB	1/2"	1 1/2"	5/8"	10-24	\$4.27	Stainless Steel Brushed
ST-050-200-10-SB	1/2"	2"	5/8"	10-24	\$4.76	Stainless Steel Brushed
ST-075-050-14-SB	3/4"	1/2"	Thru.	1/4 - 20	\$3.41	Stainless Steel Brushed
ST-075-075-14-SB	3/4"	3/4"	Thru.	1/4 - 20	\$3.50	Stainless Steel Brushed
ST-075-100-14-SB	3/4"	1"	Thru.	1/4 - 20	\$4.11	Stainless Steel Brushed
ST-075-150-14-SB	3/4"	1 1/2"	3/4"	1/4 - 20	\$4.84	Stainless Steel Brushed
ST-075-200-14-SB	3/4"	2"	3/4"	1/4 - 20	\$5.74	Stainless Steel Brushed
ST-100-050-14-SB	1"	1/2"	Thru.	1/4 - 20	\$3.77	Stainless Steel Brushed
ST-100-075-14-SB	1"	3/4"	Thru.	1/4 - 20	\$4.23	Stainless Steel Brushed
ST-100-100-14-SB	1"	1"	Thru.	1/4 - 20	\$4.69	Stainless Steel Brushed
ST-100-150-14-SB	1"	1 1/2"	3/4"	1/4 - 20	\$5.77	Stainless Steel Brushed
ST-100-200-14-SB	1"	2"	3/4"	1/4 - 20	\$6.91	Stainless Steel Brushed
ST-100-300-14-SB	1"	3"	3/4"	1/4 - 20	\$8.48	Stainless Steel Brushed
ST-125-050-516-SB	1 1/4"	1/2"	Thru.	5/16 - 18	\$4.64	Stainless Steel Brushed
ST-125-100-516-SB	1 1/4"	1"	1/2"	5/16 - 18	\$5.69	Stainless Steel Brushed
ST-125-200-516-SB	1 1/4"	2"	3/4"	5/16 - 18	\$7.05	Stainless Steel Brushed

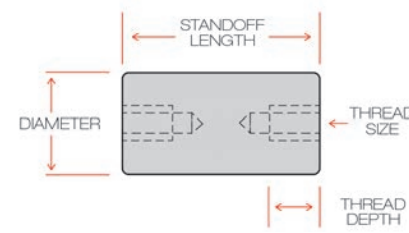
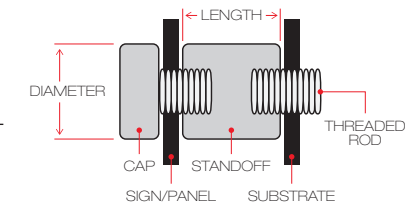

Contact us for additional sizes, finishes or quantities over 100 pieces.
Orders under \$100 will be assessed a \$17.50 shipping & handling fee.

Contact us for additional sizes, finishes or quantities over 100 pieces.
Orders under \$100 will be assessed a \$17.50 shipping & handling fee.

Threaded Standoff (Continued)

Part Number	Diameter	Length	Thread Depth	Thread Size	0-100 Pcs.	Finish
ST-125-300-516-SB	1 1/4"	3"	3/4"	5/16 - 18	\$9.14	Stainless Steel Brushed
ST-125-400-516-SB	1 1/4"	4"	3/4"	5/16 - 18	\$11.13	Stainless Steel Brushed



Table-Top Standoff

Universal legs for table top signage or displays. Can be mounted to place your sign at almost any angle. Made to fit any panel thickness (specify at time of order).

Part Number	Size	Thread Size	Max Panel Thickness	0-100 Pcs.	Finish
TTS-062-200-14-AL	5/8" x 2"	1/4 - 20	Made to order	\$6.30	Anodized Aluminum

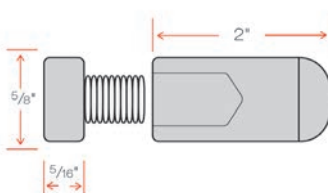

Acrylic Wall-Mount Standoffs

Acrylic Wall-Mounts come with a Flat-Top Cap and in all our standard Wall-Mount Standoff sizes. Contact us for pricing and availability.



Wall-Mount Standoff

Our Wall-Mount standoffs are the most economical and easy way to install product available. All Wall-Mount standoffs come with a self-drilling drywall anchor and mounting screw. Drive the anchor into the wall with a screwdriver and then screw the standoff to the anchor with the mounting screw. Available in domed, flat-top, and XL caps.

Part Number	Diameter	Length	0-100 Pcs.	With XL Caps	Finish
WS-050-075-AL	1/2"	3/4"	\$3.04	\$3.25	Anodized Aluminum
WS-050-100-AL	1/2"	1"	\$3.55	\$3.80	Anodized Aluminum
WS-050-150-AL	1/2"	1 1/2"	\$4.05	\$4.33	Anodized Aluminum
WS-050-200-AL	1/2"	2"	\$4.42	\$4.73	Anodized Aluminum
WS-075-100-AL	3/4"	1"	\$4.02	\$4.30	Anodized Aluminum
WS-075-150-AL	3/4"	1 1/2"	\$4.27	\$4.57	Anodized Aluminum
WS-075-200-AL	3/4"	2"	\$4.49	\$4.80	Anodized Aluminum
WS-075-250-AL	3/4"	2 1/2"	\$4.65	\$4.97	Anodized Aluminum
WS-100-100-AL	1"	1"	\$4.73	\$5.06	Anodized Aluminum
WS-100-200-AL	1"	2"	\$5.57	\$5.96	Anodized Aluminum
WS-100-300-AL	1"	3"	\$6.94	\$7.41	Anodized Aluminum
WS-100-400-AL	1"	4"	\$7.75	\$8.29	Anodized Aluminum
WS-125-100-AL	1 1/4"	1"	\$6.50	\$6.95	Anodized Aluminum
WS-125-200-AL	1 1/4"	2"	\$10.90	\$11.66	Anodized Aluminum
WS-125-300-AL	1 1/4"	3"	\$13.18	\$14.09	Anodized Aluminum
WS-125-400-AL	1 1/4"	4"	\$615.58	\$16.67	Anodized Aluminum

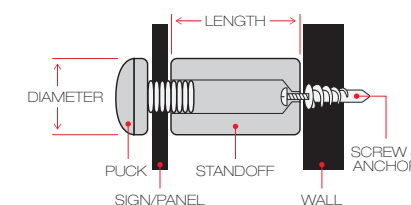

Contact us for additional sizes, finishes or quantities over 100 pieces.
Orders under \$100 will be assessed a \$17.50 shipping & handling fee.

Contact us for additional sizes, finishes or quantities over 100 pieces.
Orders under \$100 will be assessed a \$17.50 shipping & handling fee.

MISC.

These products can be paired with our standard hardware line of pucks, caps, spacers and standoffs.



Photo compliments of EXTECH/Exterior Technologies, Inc.

Thumb-Screws & Thumb-Nuts

The outside diameter has an aggressive diamond knurl to provide a solid grip. Perfect choice for applications where the cap/puck needs to be removed or adjusted periodically. Can be paired with any of the original puck, cap, spacer, and standoff hardware.

Part Number	Diameter	Thread Size	Nut Length	Thumb-Screw (with stud)	Thumb-Nut (no stud)	Finish
TN-050-10-SAL	1/2"	#10-24	3/8"	N/A	\$1.84	Satin Anodized Aluminum
TS-050-10-SAL	1/2"	#10-24	3/8"	\$2.49	N/A	Satin Anodized Aluminum
TN-062-14-SAL	5/8"	1/4 - 20	1/2"	N/A	\$1.95	Satin Anodized Aluminum
TS-062-14-SAL	5/8"	1/4 - 20	1/2"	\$2.62	N/A	Satin Anodized Aluminum

When ordering Thumb-Screws (TS-050 or TS-062), please specify needed stud length.

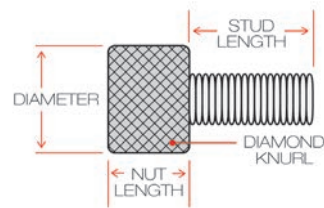

Sign Hubs

Used to mount signage or dividing panels vertically or horizontally. Excellent choice for hallway way finding signage. Can be paired with standoff hardware.

Part Number	Diameter	Height	Compatible Panel Thickness	0-100 Pcs.	Finish
SH-100-250-AL	1"	1/2"	1/4"	\$6.86	Anodized Aluminum
SH-200-050-AL	2"	3/4"	1/2"	\$8.23	Anodized Aluminum

Contact us for additional sizes, finishes or quantities over 100 pieces. Orders under \$100 will be assessed a \$17.50 shipping & handling fee.

GENERAL HARDWARE

We want to make sure you have everything you need for your project. We can source additional hardware and kit or assemble your components to meet your needs.



Zinc Wall Driller Anchor

This anchoring system is designed for drywall applications. It allows you to use any of our threaded caps and standoffs without complicated hardware. Screw the anchor into the wall and screw your cap or standoff onto the exposed threaded stud. Available in 1/4-20 and 5/16-18 threads.



Part Number	Thread Size	Exposed Stud Length	0-100 Pcs.
WD-14	1/4 - 20	3/8"	\$1.53
WD-516	5/16 - 18	3/8"	\$1.93

Compatible with all our 1/4 - 20 or 5/16 - 18 threaded hardware.

Zinc Plated Studs

We can supply you with threaded studs to go along with any of our hardware, just specify thread size and length. Please contact us for pricing.



Screws/Nuts/Bolts

Supplying you with hardware does not end with our standard or custom components. We can also supply you with any additional hardware you need to complete your project. Screws, nuts, bolts, threaded studs or anything else you are looking for, let us find it for you!



Product Kitting

Not only can we supply you with great looking hardware at a great price, we can save you time and money by sending your order to you kitted or assembled to meet your needs. Let us know what other types of hardware you need for your project and we can source, count, package and ship all your hardware together. No order is too big or too small.



Contact us for additional sizes, finishes or quantities over 100 pieces. Orders under \$100 will be assessed a \$17.50 shipping & handling fee.

MADE TO ORDER

Custom products for decorative signage without the custom price.

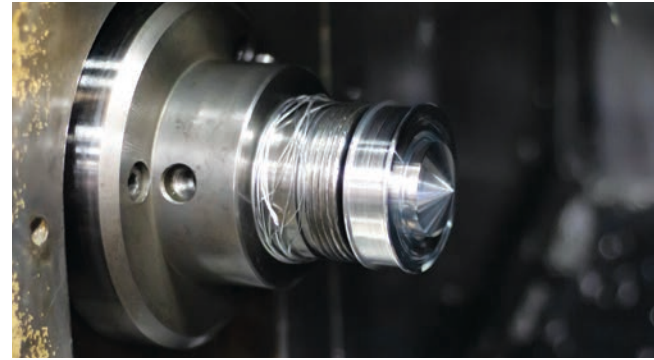

CUSTOM MACHINING

We can modify our products to meet your specifications - any size, length, thread or finish.



Cover-Caps

Anodized Aluminum Cap & Zinc Plated Steel Washer.

Used to cover plain or unsightly hardware. An effective means of discouraging people from tampering with your hardware. Easy to install - The threaded washer is used in place of a flat washer and the decorative cap is then threaded over it.

For pricing and availability, please contact us with needed diameter, height and fastener.

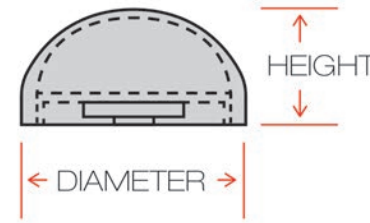

Manufacturers of displays, signage, retail fixtures, trade and museum exhibits have relied on us for top-quality hardware for more than 45 years.

Decorative signage. Display mounting blocks. Custom brackets. No matter what kind of hardware component you needs, we'll create a custom solution.

We manufacture all of our precision machined hardware, stainless steel and other components in our factory in Germantown, Wisconsin. Marlow offers complete machining capabilities supported by a close group of local, trusted vendors to fulfill any plating, coating, welding, hobbing or broaching need.

Panel Grips

For mounting tempered glass or any other material without drilling holes. Uses a nylon tipped set screw to prevent damage to your panel. Can be paired with a wide variety of mounting hardware.

For pricing and availability, please specify diameter, standoff distance, compatible panel thickness and finish.

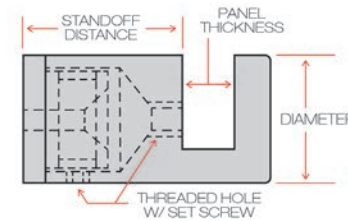

Peg-Outs

Can be used as a standoff, cap or on its own. Commonly used to support shelves or as a hanger or hanger rod to display product. Available with or without a threaded stud for mounting.

For pricing and availability, please specify diameter, length, thread size and finish.



PREVIOUSLY MADE CUSTOM PRODUCTS



Contact us for additional sizes, finishes or quantities over 100 pieces.
Orders under \$100 will be assessed a \$17.50 shipping & handling fee.

Contact us for additional sizes, finishes or quantities over 100 pieces.
Orders under \$100 will be assessed a \$17.50 shipping & handling fee.

CAP/PUCK COMPONENT

(SIDE VIEW)

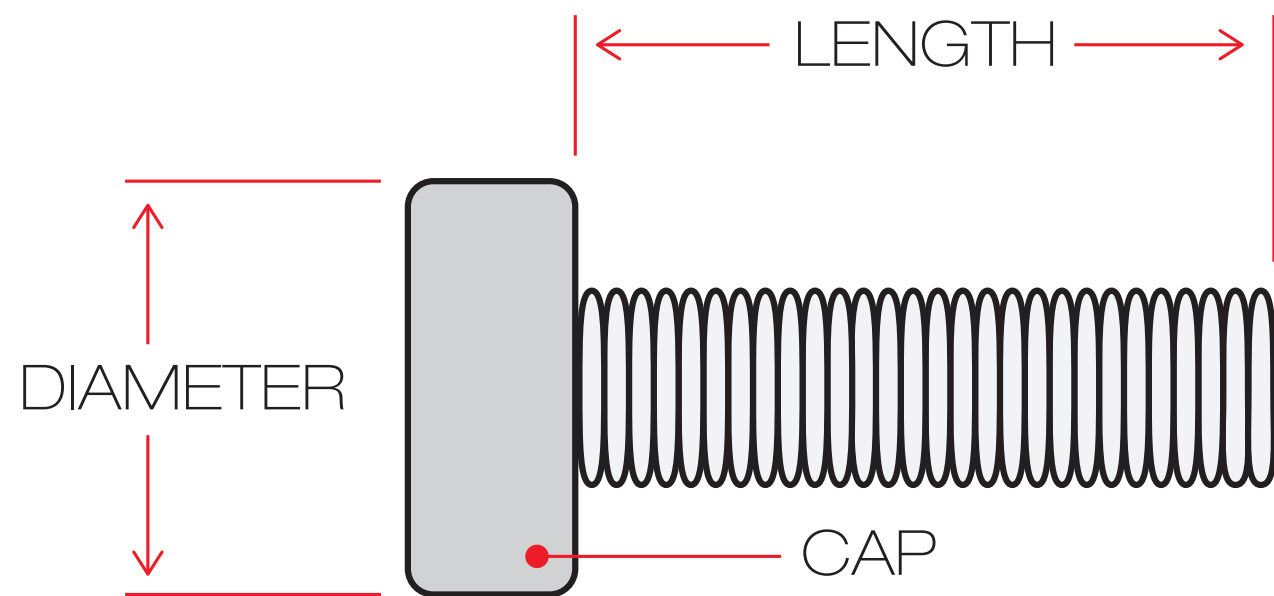

STANDOFF COMPONENT

(SIDE VIEW)

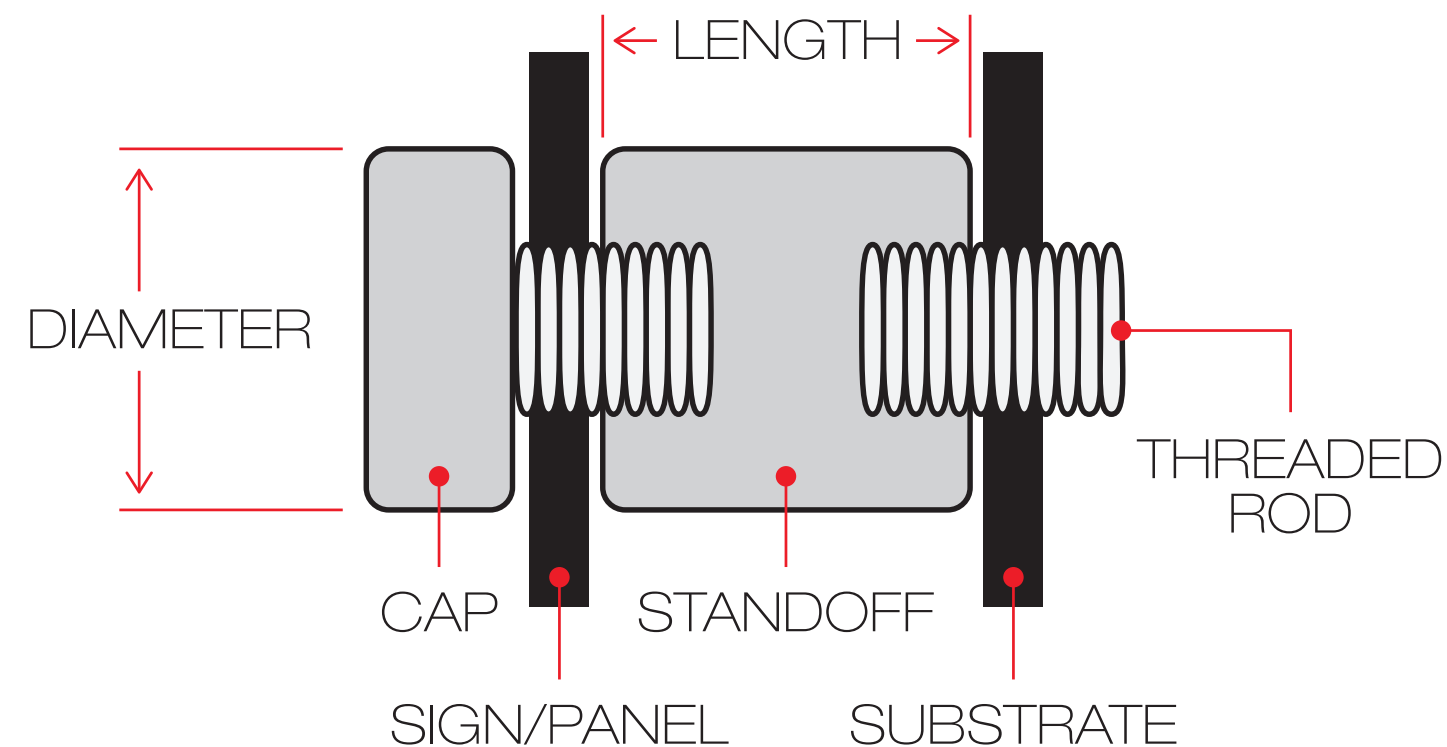

SPACER COMPONENT

(SIDE VIEW)

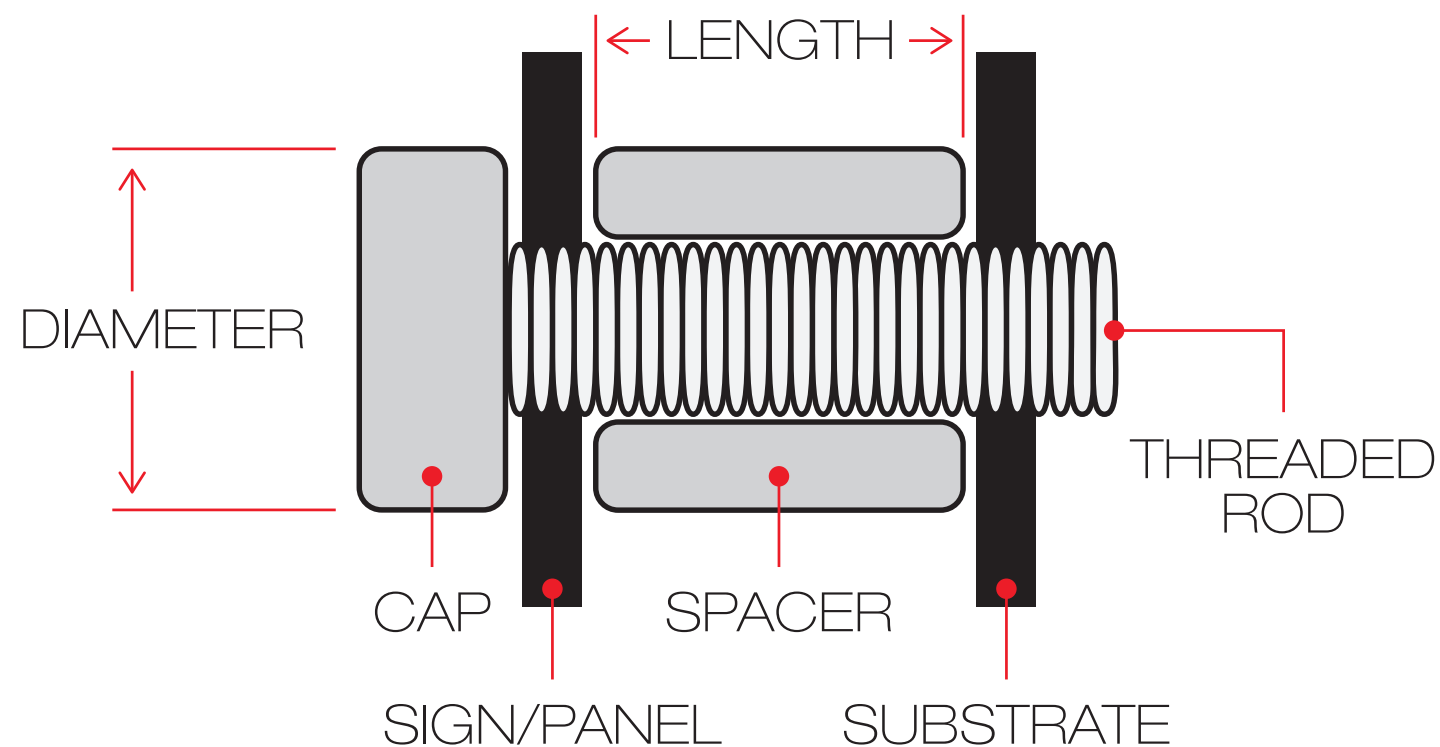

WALL-MOUNT COMPONENT

(SIDE VIEW)

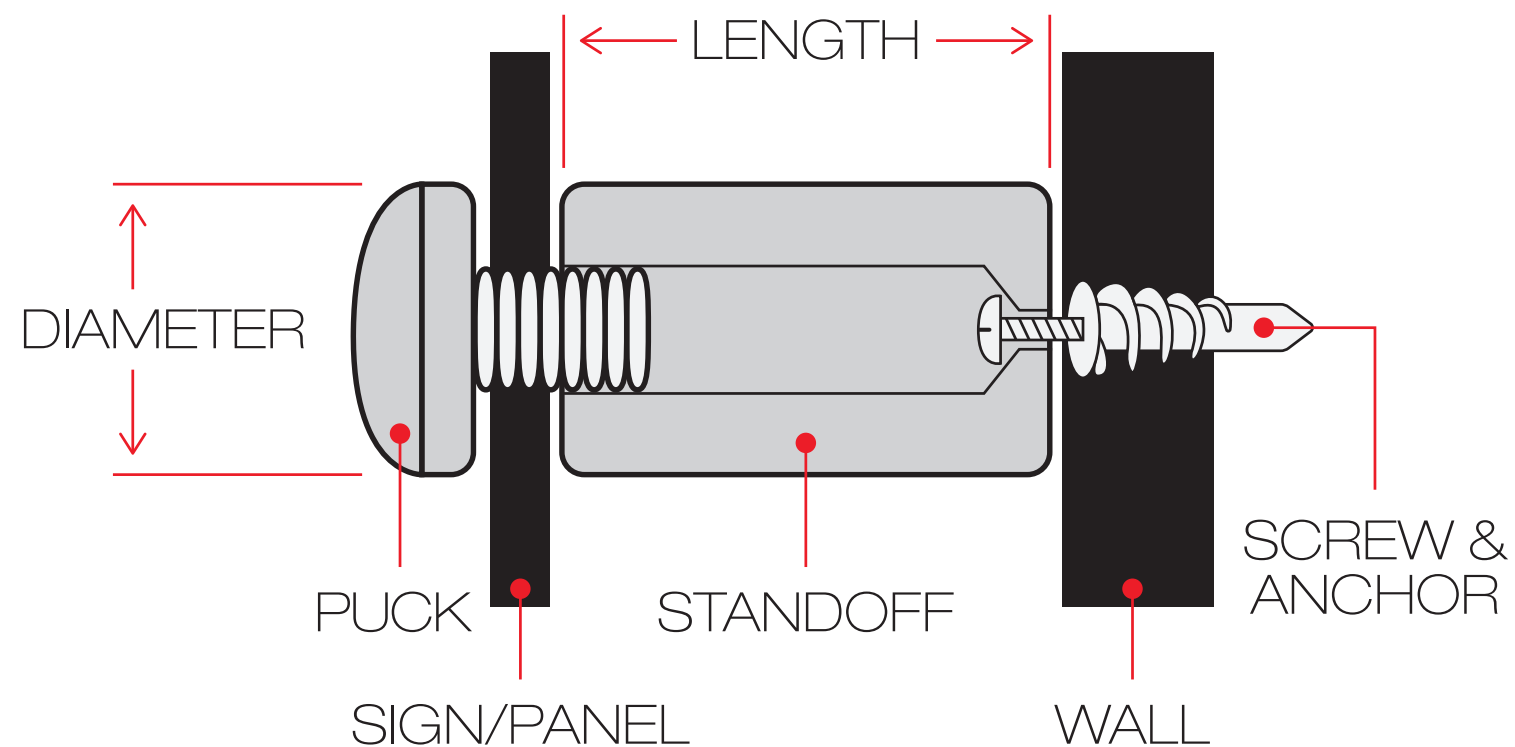



Steve Marlow | Vice President

ABOUT US...

At Marlow, we excel in innovation.

Marlow Machining is a tightly-knit, family run manufacturer. Our team of highly experienced craftspeople is committed to meeting deadlines and delivering the best quality. If you have an idea, we'll work with you to make it happen at the best value possible. We will turnaround quotes in 24 hours or less, even for custom orders. And we ensure responsive and honest communication on delivery status.

Our goal is to meet your requirements in the most efficient, productive way possible. We're here to listen to you, respect your time and money, and make the process as easy as possible. Keeping promises to our customers is what we do best.

With over 45 years of experience, we've proven ourselves time and time again.

We have a long and consistent experience with manufacturing and machining. Don Marlow began this business originally in his basement in 1973, taking his passion for quality, custom metalworking to an evolving business. Marlow has grown in many ways in the years since then, but the sense of family and passion within the company have not left. In fact, the employee who's been at Marlow for the least amount of time still has almost two decades with the company.

That's family. That's dedication. That's Marlow.

OUR HISTORY

GENERAL TERMS AND CONDITIONS OF SALE

Customer Service: Ordering by phone - 1-262-255-6667 / by fax 1-262-255-7168.

Terms of Sale: 1% 10 days, net 30. Invoice will be sent within 3 days of shipment. We require first time customers to make payment by credit card at time of sale.

Freight Terms: All shipments will be made via transportation company selected by customer of "Best Way" if not selected by customer. Freight charges are to be paid by customer. There is a \$17.50 shipping and handling fee for orders under \$100 unless otherwise stated.

Claims Terms: All claims for damaged or incomplete shipments must be made within 48 hours after receipt of goods or it will be assumed shipment was without damage and complete. Marlow Inc. assumes no liability after this point. Claims for loss or damage on shipments must not be deducted from our invoice.

Guarantee: We will fully support the quality of any product. If there are any manufacturing defects, please contact us immediately.

Disclaimer of Warranty: Marlow Inc. makes no express or implied warranties, including, but not limited to, any implied warranty of merchantability or fitness for a particular purpose. Any use to which the goods are put would be subject to buyer's own testing and acceptance for purposes intended.

Catalog Errors: This catalog has been reviewed to present all information and prices as accurately as possible. Should an error be found in description or price, we reserve the right to correct it.

Law: The laws of the state of Wisconsin shall govern the validity, construction and interpretation of the rights and duties of the parties defined in the terms and conditions of this agreement as stated.

Address

N114 W18548 Clinton Drive,
P.O. Box 835,
Germantown, WI 53022

Phone: (262) 255-6667

Fax: (262) 255-7168

Email: pam@marlowmachining.com
steve@marlowmachining.com

Hours

Mon-Thu 7am-4pm
Fri 7am-3pm
Sat-Sun Closed



MARLOWMACHINING.COM

Phone: (262) 255-6667 | **Fax:** (262) 255-7168

pam@marlowmachining.com | steve@marlowmachining.com